



**Whamcloud**

## Lustre 2.12 and Beyond

Andreas Dilger, Whamcloud

# Upcoming Release Feature Highlights

## ▶ 2.12 is feature complete

- LNet Multi-Rail Network Health – improved fault tolerance
- Lazy Size on MDT (LSOM) – efficient MDT-only scanning
- File Level Redundancy (FLR) enhancements – usability and robustness
- T10 Data Integrity Field (DIF) – improved data integrity
- DNE directory restriping – better space balancing and DNE2 adoption

## ▶ 2.13 development and design underway

- Persistent Client Cache (PCC) – store data in client-local NVMe
- File Level Redundancy – Phase 2 Erasure Coding
- DNE auto remote directory/striping – improve load/space balance across MDTs

## ▶ 2.14 plans continued functional and performance improvements

- DNE directory auto-split – improve usability and performance of DNE2
- Client metadata Write Back Cache (WBC) – improve interactive performance, reduce latency

- ▶ Detect network interface and router failures automatically
  - Builds on LNet Multi-Rail in 2.10/2.11 ([LU-9120](#) Intel/WC, HPE/SGI)
  - **LNet fault tolerance** without lengthy Lustre recovery, optimize resend path
  - Handle multi-interface router failures

DONE

- ▶ User Defined Selection Policy ([LU-9121](#) WC, HPE)

TODO

- Fine grained control of interface selection
  - TCP vs. IB networks, primary vs. backup
- Optimize RAM/CPU/PCI data transfers
- Useful for large NUMA machines

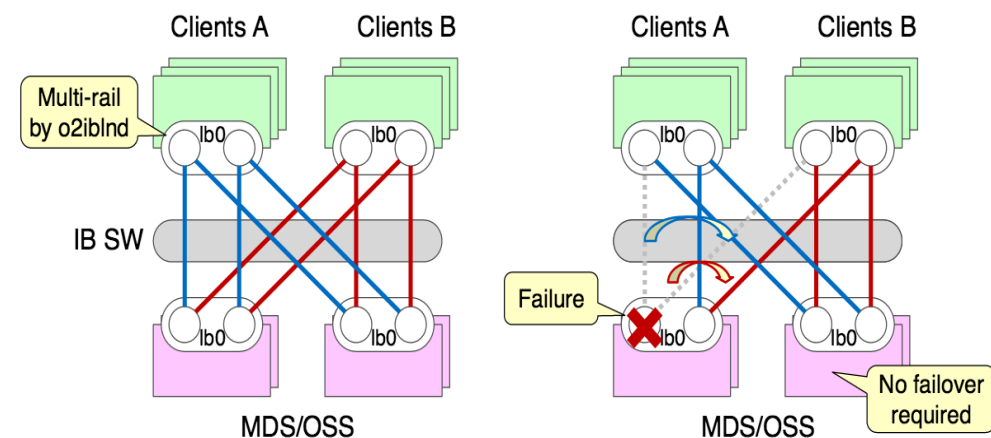

# Data-on-MDT Improvements

([LU-10176](#) WC 2.12+)



Whamcloud

▶ Complementary with DNE 2 striped directories

- Scale small file IOPS with multiple MDTs

▶ **Read-on-Open** fetches data ([LU-10181](#))

- Reduced RPCs for common workloads

▶ Improved locking for DoM files ([LU-10175](#))

- Drop layout lock bit without full IBITS lock cancellation
- Avoid cache flush and extra RPCs
- Convert write locks to read locks

▶ Migrate file/component from MDT to OST ([LU-10177](#))

DONE

▶ Migrate file/component from OST to MDT via FLR ([LU-11421](#))

TODO

▶ Cross-file data prefetch via statahead ([LU-10280](#))

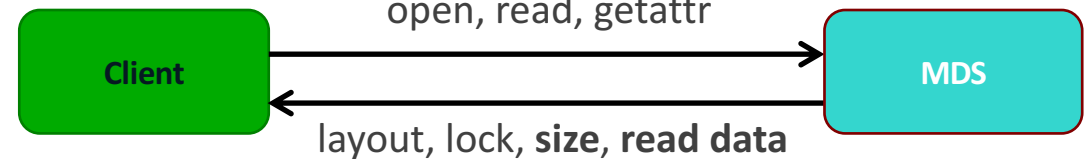

Small file read directly from MDS

# DNE Improvements

(WC 2.12/2.13)



Whamcloud

▶ **Directory restriping** from single-MDT to striped/sharded directories ([LU-4684](#))

- Rebalance MDT space usage, improve large directory performance

▶ Automatically create new remote directory on "best" MDT with `mkdir()`

- Simplifies use of multiple MDTs without striping all directories, similar to OST usage
- In 2.11 in userspace for `lfs mkdir -i -1` ([LU-10277](#))

DONE

▶ **Automatic MDT load balancing** at directory creation time ([LU-10784](#), [LU-11213](#))

TODO

- Using standard `mkdir()` calls with `parent stripe_idx = -1`

▶ **Automatic directory restriping** as directory size grows ([LU-11025](#))

- Create one-stripe directory for low overhead, scale shards/capacity/performance with size
- Add extra directory shards when master directory grows large enough (e.g. 10k entries)
- Move existing direntries to new directory shards
- New direntries and inodes created on new MDTs

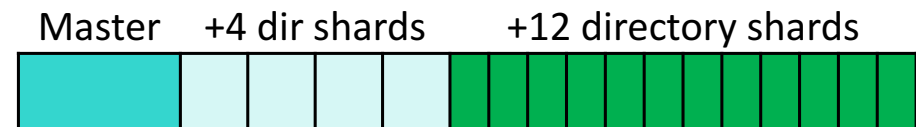

## ZFS Enhancements Related to Lustre

(2.12+)   
Whamcloud

- ▶ Lustre 2.12 osd-zfs updated to use ZFS 0.7.9
  - Bugs in ZFS 0.7.7/0.7.10/0.7.11, not used by Lustre branch
  - Builds with upstream ZFS pre-0.8.0 branch
- ▶ **Features in ZFS 0.8.x** release (target 2019Q1)
  - Depends on final ZFS release date, to avoid disk format changes
  - Sequential scrub/resilver (Nexenta)
  - On-disk data encryption + QAT hardware acceleration (Datto)
  - **Project quota** accounting (Intel)
  - **Device removal** via VDEV remapping (Delphix)
  - **Metadata Allocation Class** (Intel, Delphix) **LANDED**
  - Declustered Parity RAID (dRAID) (Intel) **IN PROGRESS**



# Miscellaneous Improvements

- ▶ **UID/GID policy** for Token Bucket Filter (NRS-TBF) ([LU-9658](#) DDN)
- ▶ Improved JobStats allows admin-formatted JobID ([LU-10698](#) Intel)  
`lctl set_param jobid_env=SLURM_JOB_ID jobid_name=cluster2.%j.%e.%p`
- ▶ HSM infrastructure improvement & optimizations (Intel/WC, Cray)
  - Improve Coordinator ([LU-10699](#)), POSIX Copytool ([LU-11379](#)), > 32 archives ([LU-10114](#)), ...
- ▶ **Lazy Size-on-MDT** for local scan (purge, HSM, policy engine) ([LU-9358](#) DDN)
  - LSOM is not guaranteed to be accurate, but good enough for many tools
  - LSOM made available on client for apps *aware of limitations* (e.g. `lfs find`, `statx()`, ...)
- ▶ **Lustre-integrated T10-PI** end-to-end data checksums ([LU-10472](#) DDN)
  - Pass data checksums between client and OSS, avoid overhead, integrate with hardware **DONE**
- ▶ Dump/restore of `conf_params/set_param -P` parameters ([LU-4939](#) Cray) **TODO**  
`lctl --device MGS llog_print testfs-client > testfs.cfg; lctl set_param -F testfs.cfg`

# Improved Client Efficiency

(2.12+)   
Whamcloud

- ▶ **Disconnect idle clients** from OSS ([LU-7236](#) Intel)
  - Reduce memory usage on client and server for large systems
  - Reduce network pings and recovery times
- ▶ **Aggregate statfs()** RPCs on the MDS ([LU-10018](#) WC)
  - Reduce OSS overhead, avoid idle OST reconnection on client df

DONE

- 
- ▶ **Improved client read performance** ([LU-8709](#) DDN)
    - Improved readahead code, asynchronous IO submission
  - ▶ **Reduce wakeups and background tasks on idle clients** ([LU-9660](#) Intel)
    - Synchronize wakeups between threads/clients (per jobid?) to minimize jitter
    - Still need to avoid DOS of server if all clients ping/reconnect at same time

TODO



# Performance Improvements for Flash

(WC 2.12+)   
Whamcloud

- ▶ **Reduce server CPU** overhead to improve small flash IOPS
  - Performance is primarily CPU-limited for small read/write
  - Any reduction in CPU usage directly translates to improved IOPS
- ▶ **Avoid page cache** on flash OSS ([LU-11347](#))
  - Avoids CPU overhead/lock contention for page eviction
  - Streaming flash performance is often network limited
  - ZFS drops pages from cache after use ([LU-11282](#))
- ▶ Improved efficiency of ZFS IO pipeline
  - Integrate with ABD in ZFS 0.8 to avoid memcpy( ) of data
  - Further improvements with continued investigation/development

DONE

TODO

# FLR Enhancements

(WC 2.12+)



Whamcloud

- ▶ Continuation of FLR feature landed in Lustre 2.11 ([LU-9771](#))
- ▶ FLR-aware OST object allocator to avoid replicas on same OST/OSS ([LU-9007](#))
- ▶ Improve "lfs mirror resync" performance ([LU-10916](#))
  - Optimize multi-mirror resync (read data once, write multiple mirrors)
- ▶ "lfs mirror read" to dump specific mirror/version of file ([LU-11245](#))
- ▶ "lfs mirror write" for script-based resync ([LU-10258](#))
- ▶ **Mirror NOSYNC flag + timestamp to allow file version/snapshot** ([LU-11400](#)) DONE

---

- ▶ Improved replica selection at runtime ([LU-10158](#)) TODO
  - Select best write replica (PREFERRED, SSD vs. HDD , near to client), read (many mirror vs. few)
  - Allow specifying fault domains for OSTs (e.g. rack, PSU, network switch, etc.)
- ▶ Mount client directly on OSS for improved resync performance ([LU-10191](#))
- ▶ Support DoM components ([LU-10112](#))
- ▶ Pool or OST/MDT quotas ([LU-11023](#))
  - Track/restrict space usage on flash OSTs/MDTs
- ▶ **Erasure Coded** striped files ([LU-10911](#))

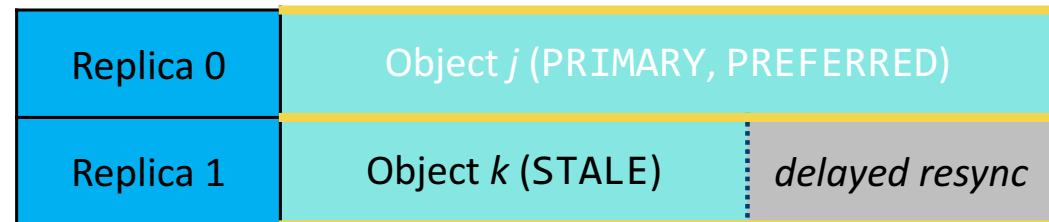

# Persistent Client Cache (PCC)

([LU-10092](#) DDN, WC 2.13+)



Whamcloud

- ▶ Reduce latency, improve small/unaligned IOPS, reduce network traffic
- ▶ PCC integrates Lustre with persistent per-client local cache devices
  - Each client has own cache (SSD/NVMe/NVRAM) as a local filesystem (e.g. ext4/ldiskfs)
  - No global/visible namespace is provided by PCC, data is local to client only
  - Existing files pulled into PCC by HSM copytool per user directive, job script, or policy
  - New files created in PCC is *also* created on Lustre MDS
- ▶ Kernel uses local file if in cache or normal Lustre IO
  - Further file read/write access “directly” to local data
  - No data/IOPS/attributes leave client while file in PCC
  - File migrated out of PCC via HSM upon remote access
- ▶ Separate functionality read vs. write file cache
- ▶ Could later integrate with DAX for NVRAM storage

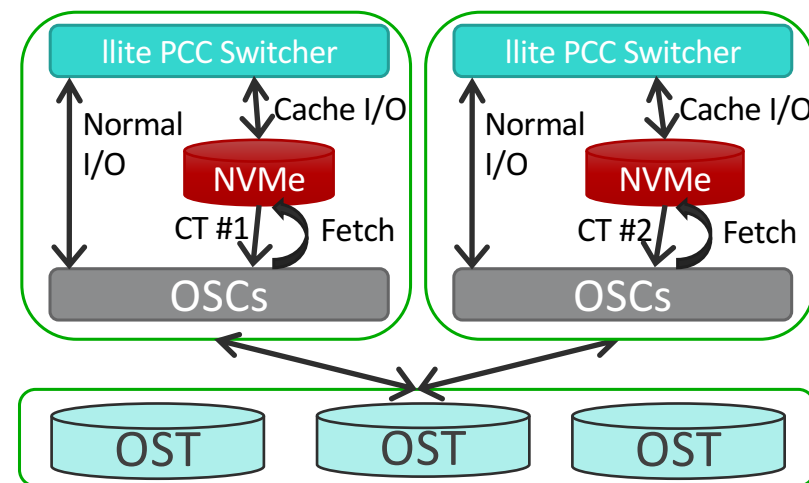

# Client Metadata Writeback Cache (WBC)

([LU-10983](#) 2.14+)



Whamcloud

- ▶ Metadata WBC creates new files in RAM in *new directory*
  - Avoid RPC round-trips for each open/create/close
  - Lock directory exclusively, avoid other DLM locking
  - Cache file and directory data only in pagecache until flush
  - Flush tree incrementally to MDT/OST in background batches
- ▶ Could prefetch directory contents for existing directory
- ▶ Can integrate with PCC to avoid initial MDS create/write
- ▶ Early WBC prototype in progress
  - Discussions underway for how to productize it
  - Early results show 10-20x improvement for some workloads

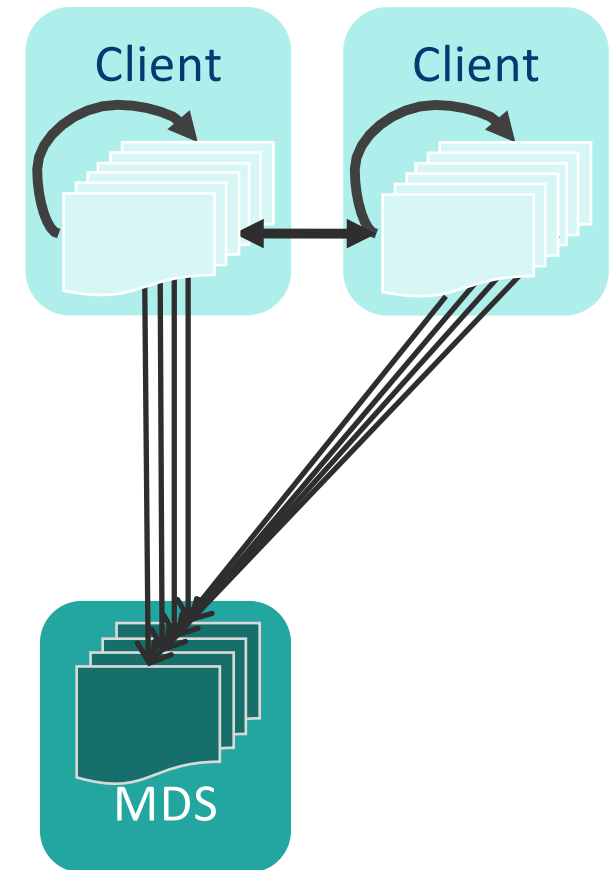

# Client Container Image (CCI)

(2.14+)   
Whamcloud

- ▶ Filesystem images have had *ad hoc* with Lustre in the past
  - Read-only cache of many small files manually mounted on clients
  - Root filesystem images for diskless clients
- ▶ **Container Image is local ldiskfs image** mounted on client
  - Holds a whole directory tree stored as a single Lustre file
  - **Useful for workloads that are mostly self-contained**
- ▶ CCI integrates container handling with Lustre
  - Mountpoint is registered with Lustre for automatic mount
  - Image file read on demand from OST(s) and/or cached in PCC
  - **Low I/O overhead, few file extent lock(s), high IOPS per client**
  - Access, migrate, replicate image with large read/write to OST(s)
- ▶ MDS can mount and re-export image files for shared use
- ▶ CCI can hold archive of whole directory tree for HSM
- ▶ Unregister/delete image and all files therein with a few ops

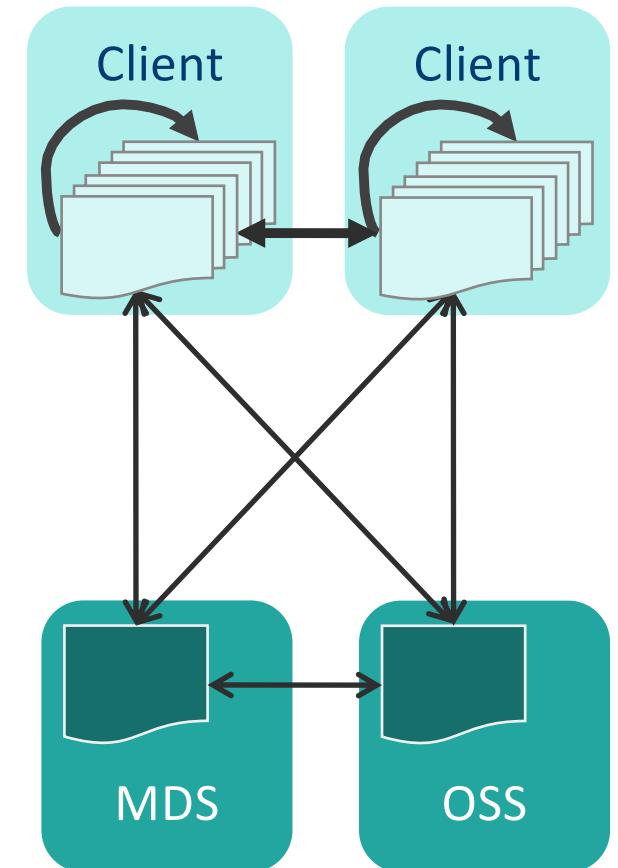



**Whamcloud**

# Kernel Code Cleanup

(ORNL, SuSE, Intel, WC, Cray)



Whamcloud

- ▶ Lustre client removed from kernel 4.17 ☹
  - Work continuing on client cleanups *for* upstream at <https://github.com/neilbrown/linux>
- ▶ Lustre 2.12 updates for kernel 4.14/4.15 ([LU-10560](#)/[LU-10805](#))
- ▶ Improve kernel time handling (Y2038, jiffies) ([LU-9019](#))
- ▶ Ongoing /proc -> /sys migration and cleanup ([LU-8066](#))
  - Handled transparently by `lctl / llapi_*` - please use them
- ▶ Cleanup of `wait_event`, `cfs_hash_*`, and many more internals
- ▶ Some builds/testing with ARM64/Power8 clients ([LU-10157](#) little-endian!)
- ▶ Major `ldiskfs` features merged into upstream `ext4/e2fsprogs`
  - Large `xattr (ea_inode)`, directories > 10M entries (`large_dir`)
  - `dirdata` feature not yet merged (needs test interface)

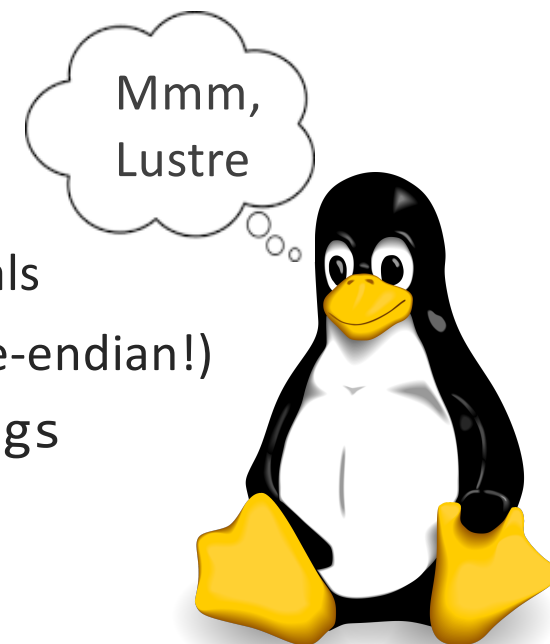

# Tiered Storage with FLR Layouts

- ▶ Integration with job scheduler and workflow for file prestage/drain/archive
- ▶ Policy engine to manage migration between tiers, rebuild replicas, ChangeLogs
  - Policies for pathname, user, extension, age, OST pool, mirror copies, ...
  - FLR provides mechanism for safe migration of (potentially in-use) data
  - RBH or LiPE are good starting points for this
- ▶ Needs userspace integration and Lustre hooks
  - Integrated burst buffers a natural starting point
  - Mirror to flash, mark PREFERRED for read/write
  - Resync modified files off flash, release space
- ▶ Need OST/MDT/pool quotas to manage tiers

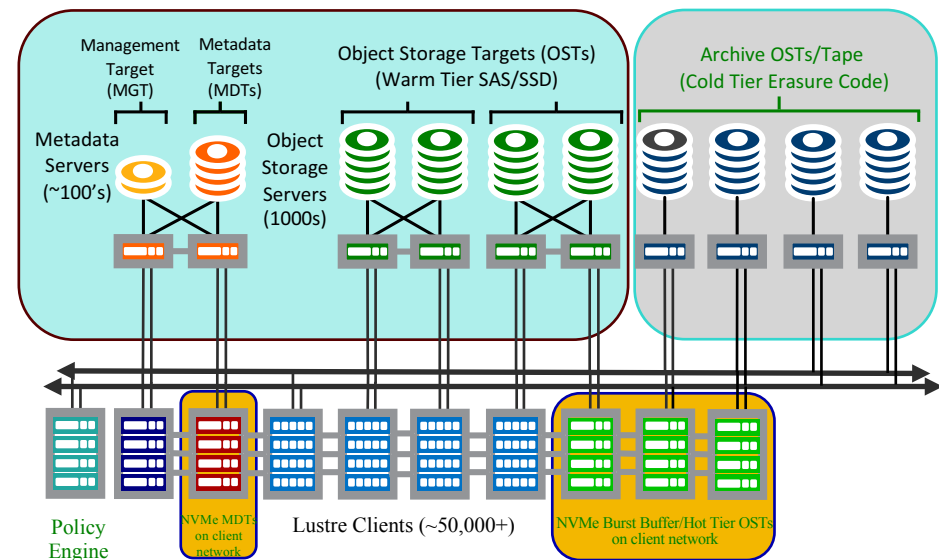



# FLR Erasure Coded Files

([LU-10911](#) WC 2.13+)



Whamcloud

- ▶ Erasure coding adds redundancy without 2x/3x overhead
- ▶ Add erasure coding to new/old striped files *after* write done
  - Use delayed/immediate mirroring for files being actively modified
- ▶ For striped files - add N parity per M data stripes (e.g. 16d+3p)
  - Parity declustering avoids IO bottlenecks, CPU overhead of too many parities
    - e.g. split 128-stripe file into 8x (16 data + 3 parity) with 24 parity stripes

dat0	dat1	...	dat15	par0	par1	par2	dat16	dat17	...	dat31	par3	par4	par5	...
0MB	1MB	...	15M	p0.0	q0.0	r0.0	16M	17M	...	31M	p1.0	q1.0	r1.0	...
128	129	...	143	p0.1	q0.1	r0.1	144	145	...	159	p1.1	q1.1	r1.1	...
256	257	...	271	p0.2	q0.2	r0.2	272	273	...	287	p1.2	q1.2	r1.2	...